

Solutions for Industrial Inspection

Image-based inspection with
minimal pseudo-error rate

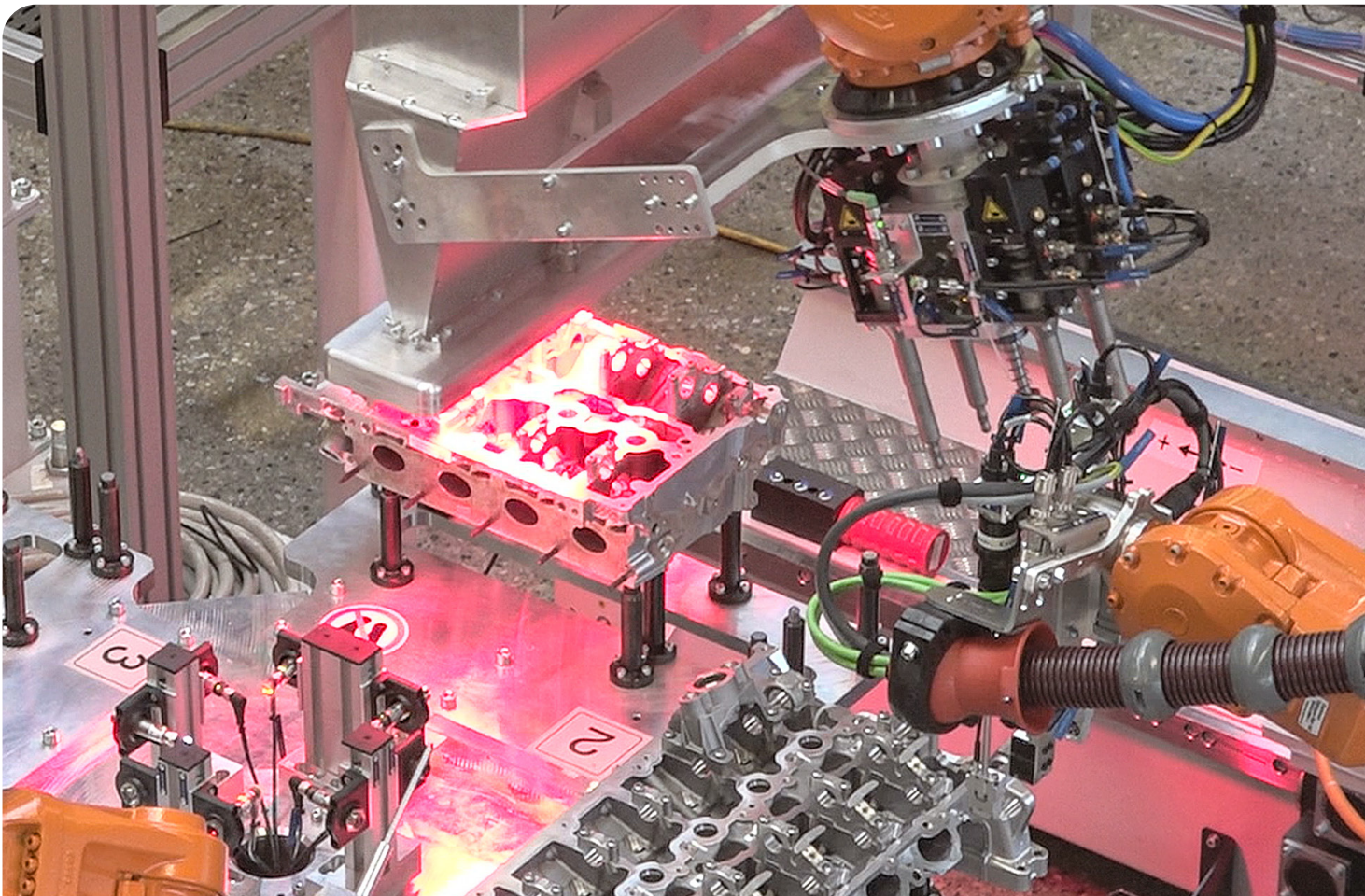

PROFACTOR topographic sensor technology

Intelligent 3D defect detection to achieve minimal pseudo-error rates

Automated surface inspection is an important tool for fast and comprehensive quality control in the line or at the end of a production process. The goal is not only to inspect many different surfaces (inside and outside), even in short cycle times, but also the correct classification of many different defect characteristics.

Conventional two-dimensional optical processes cannot generally distinguish between three-dimensional defects and purely optical defect-like surface features. As a result, this leads to high pseudo-error rates (false negatives) and, as a result, to extra effort in the form of manual post-inspection.

PROFACTOR solution

The inspection technology developed by PROFACTOR is based on a 3D approach and combines different illumination directions with high-resolution 2D cameras. By superimposing and automatically evaluating shadow images, defects such as scratches, inclusions, etc. can be correctly distinguished from pseudo errors such as noncritical contamination.

- » Special sensors developed in-house allow the inspection of outer surfaces, recesses and drilled holes up to 4 mm in diameter
- » High information density, by recording separate images in up to 5 different illumination directions
- » Images are segmented according to various parameters (position, size, depth, etc.)
- » AI-based classification and evaluation enables a reliable pass/fail assessment

Advantages

- » Robust pass/fail decisions
- » Low pseudo-error rate, especially with process-related discoloration or liquid residues
- » AI-based classification based on over 20 defect parameters
- » Short cycle times due to high scanning speed or multi-sensor systems
- » Based on many years of experience in industrial surface inspection

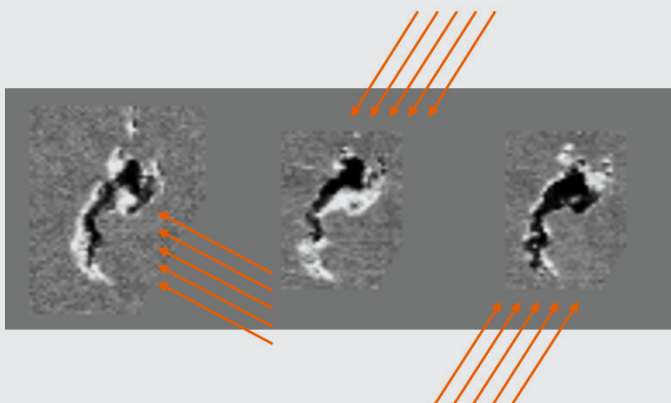
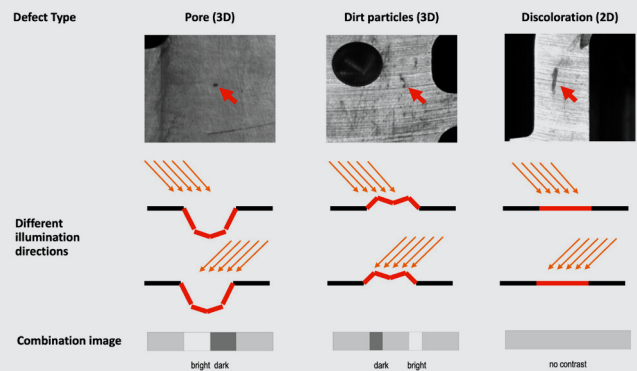

Image of a pore with different illumination directions



Robust differentiation between 3D and 2D effects

Sensors for surface inspection

Tailored sensor designs for surfaces and drilled holes



TPScan Sensor

This sensor is specially designed for fast and precise inspection of large, flat surfaces.

Up to 5 illumination directions enable the detection of 3D defects and at the same time reliable differentiation from noncritical optical features such as discoloration.

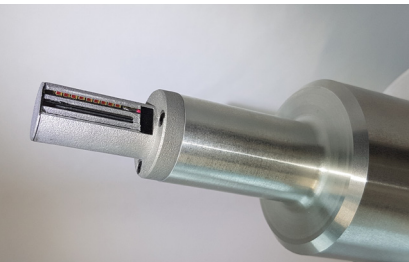

Rotating sensor

If the inner surfaces of drilled holes, radii, recesses, etc. need to be inspected for defects, rotating sensors are the ideal solution.

This sensor is based on a rotating camera movement and thus enables the inspection of the lateral surfaces of drilled holes.



Linear bore sensor

In contrast to the rotating sensor, the linear bore sensor captures the image by moving the sensor in the direction of the bore axis.

Very deep holes can be inspected. Individual sensor lengths are possible.



Linear sensor for lateral surfaces

This sensor includes a high-resolution camera and an integrated lighting unit.

It is flexible and individually adaptable to specific measurement requirements, and its compact form factor makes it easy to integrate.

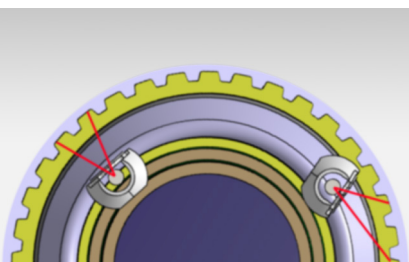

Tooth flank sensor – Available from Q4/2024

This flexible sensor design enables the inspection of internal gears of various diameters.

The arrangement of three sensors guarantees fast, precise and simultaneous inspection of the surfaces of the tooth flanks and tip.

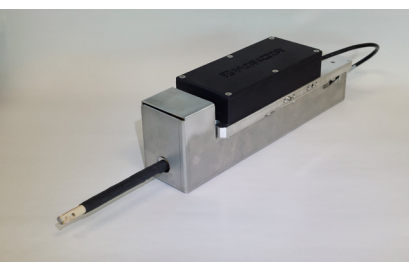

Endoscope sensor

Endoscope sensors are designed for narrow or deep drilled holes, or surfaces that cannot be reached by other sensors due to their size. Our fixed endoscope sensor can be used to inspect drilled holes up to a diameter of 4 mm.

TPScan sensor

Rapid inspection of component surfaces

How it works

The TPScan sensor is specially designed for the fast and precise inspection of surfaces. The special off-axis illumination from up to 5 directions enables the detection of 3-dimensional surface defects. At the same time, a reliable distinction can be made between critical flaws, defects and discolorations.

Areas of application

- » machined metal components (e.g. engine blocks, electric motor housings, cylinder heads, crankshafts, ground shafts, shafts with splines)
- » unmachined cast or forged components
- » coated surfaces or plastic surfaces
- » functional layers (e.g. in battery cells)
- » wooden surfaces

Models and specifications

The sensors typically operate at a scanning speed of up to 350 mm/sec. Individual special solutions can also be supplied with a resolution of up to 50 µm/px.

Customized designs, other form factors or scan widths (> 400 mm) are possible on a project-specific basis.



TPScan Sensor 400



TPScan Sensor 180

Sensor Type	400-WD-ID	180-WD-ID
Scan width	400 mm	180 mm
Resolution	100 µm/px	
Working distances (WD)	25 mm, 120 mm, 180 mm	
Illumination directions (ID)	4 or 5	
Smallest detectable defect	300 x 300 µm	

Sensor dimensions

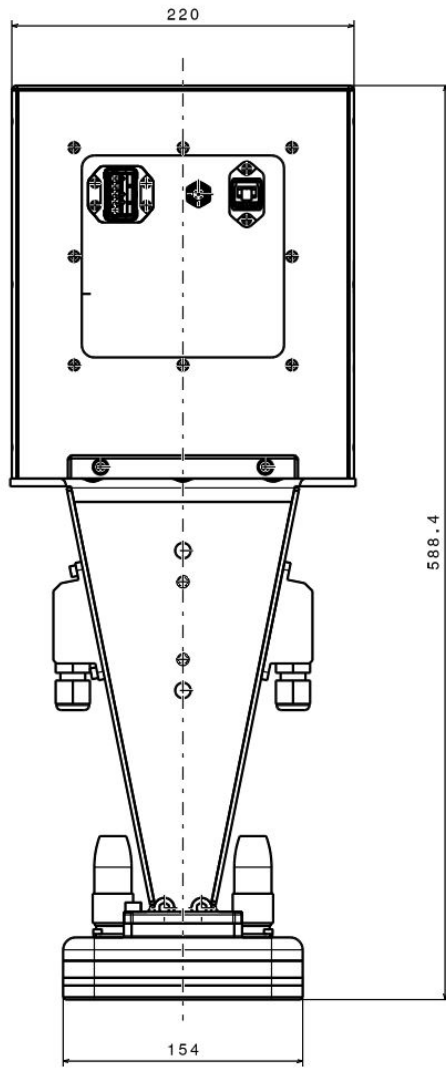

TPScan Sensor 400

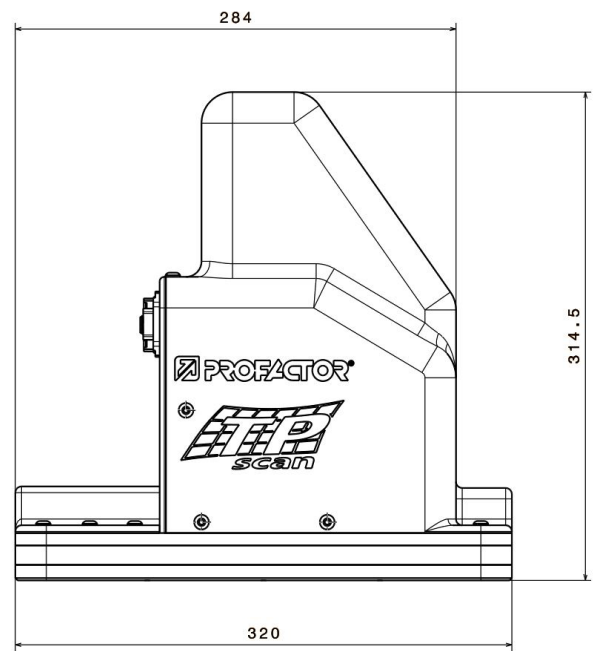

TPScan Sensor 180

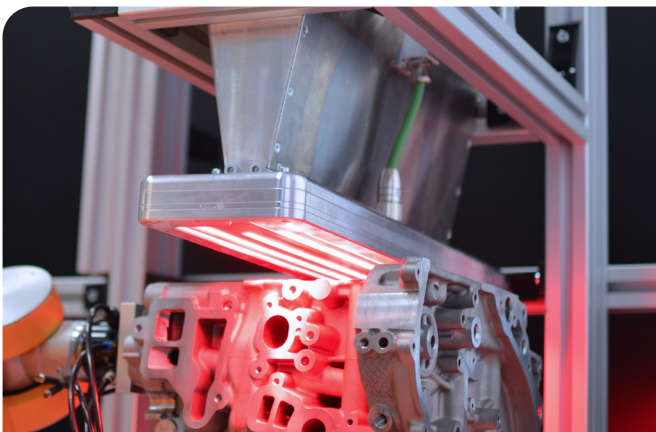

Engine block inspection with TPScan Sensor 400

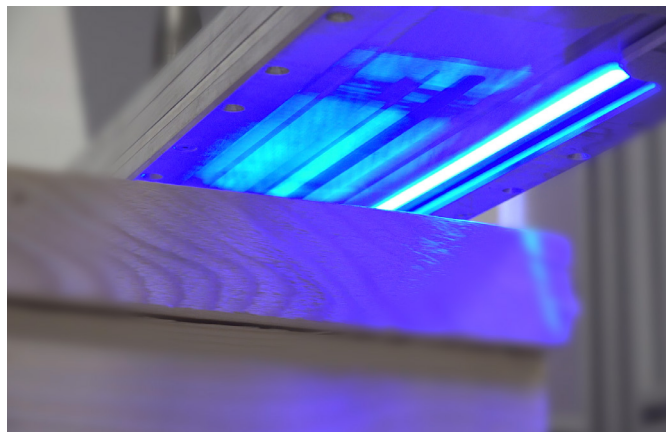

Inspection of wooden surfaces with TPScan Sensor 400

Rotating sensors (fixed diameter)

Inspection of lateral surfaces of drilled holes

How it works

In many cases, drilled holes must have defect-free surfaces. The PROFAC-TOR rotating sensor is based on a rotating camera movement combined with illumination from two directions and thus enables the inspection of the lateral surfaces of the holes.

Areas of application

- » Machined components (e.g. engine blocks, electric motor housings, cylinder heads, etc.)
- » Drilled holes
- » Recesses and radii
- » Components made of different materials (e.g. metal, plastic, wood)

Models and specifications

The rotating sensor with fixed diameter is available in three standard versions. Individual designs, other form factors or other fixed diameters are possible on a project-specific basis.

The sensors typically operate at a scanning speed of up to 100 mm/sec.

Individual special solutions can also be supplied with a resolution of up to 50 $\mu\text{m}/\text{px}$.

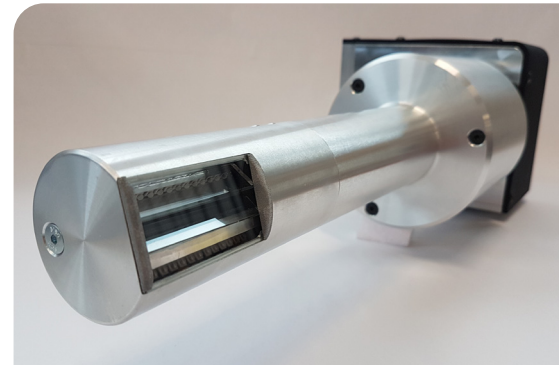

D62-F rotating sensor

Sensor type	D20-F	D62-F	D170-F
Measuring range (diameter)	20-21.6 mm	62-78 mm	170-220 mm
Scan width	10 mm	40 mm	120 mm
Scan resolution	100 $\mu\text{m}/\text{px}$		
Illumination directions (ID)	2+1		
Smallest detectable defect	300 x 300 μm		

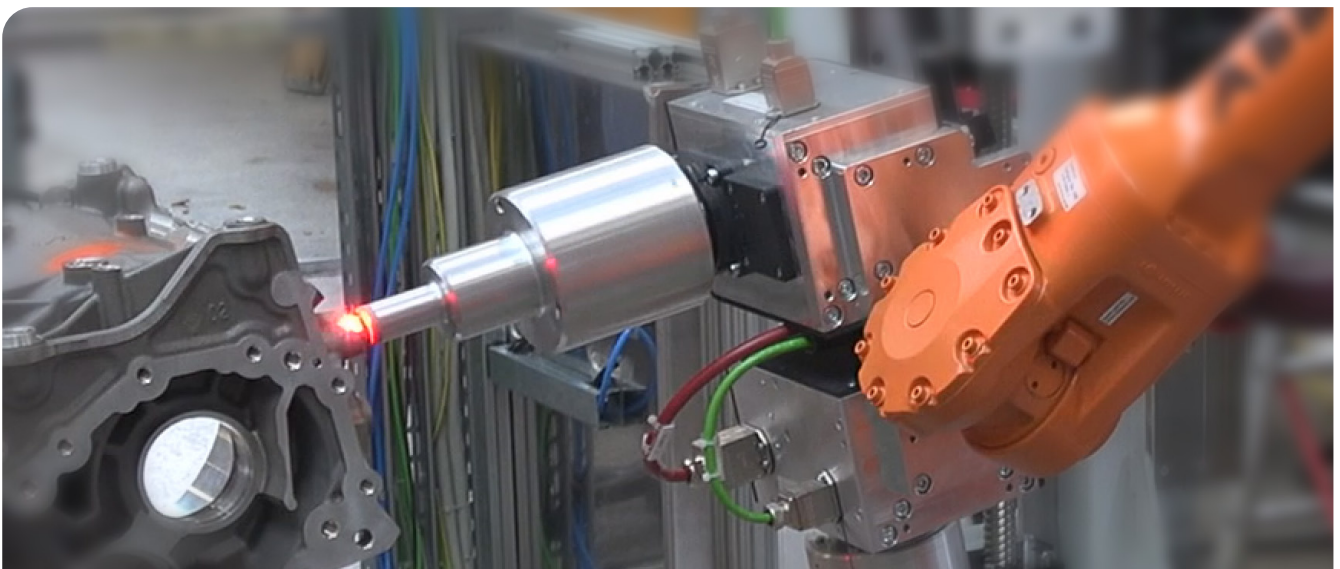

D20-F rotating sensor during hole inspection

Rotating sensor with steplessly adjustable diameter

Flexible inspection of drilled holes of different sizes

How it works

For even more flexible inspection solutions, a rotating sensor is currently being developed with a continuously electrically adjustable diameter.

The radial adjustment mechanism makes it possible to adapt to different diameter requirements in a component.

There is no need to change the sensors in an inspection task. This results in cost savings due to the elimination of several individual sensors and reduces the complexity of the inspection system.

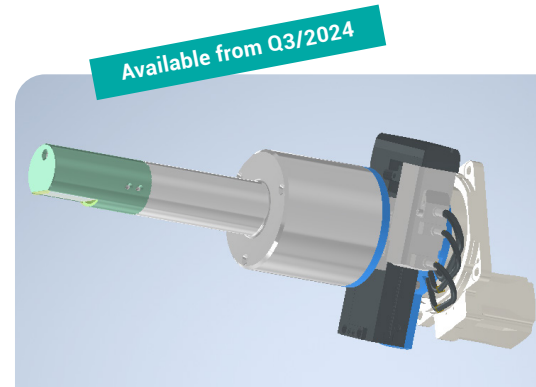

Areas of application

- » Highly complex components and diverse measurement requirements
- » Highly flexible inspection stations or batch size 1
- » Generally applies to all areas of application of our fixed-diameter rotating sensors

Comparison of available rotating sensors

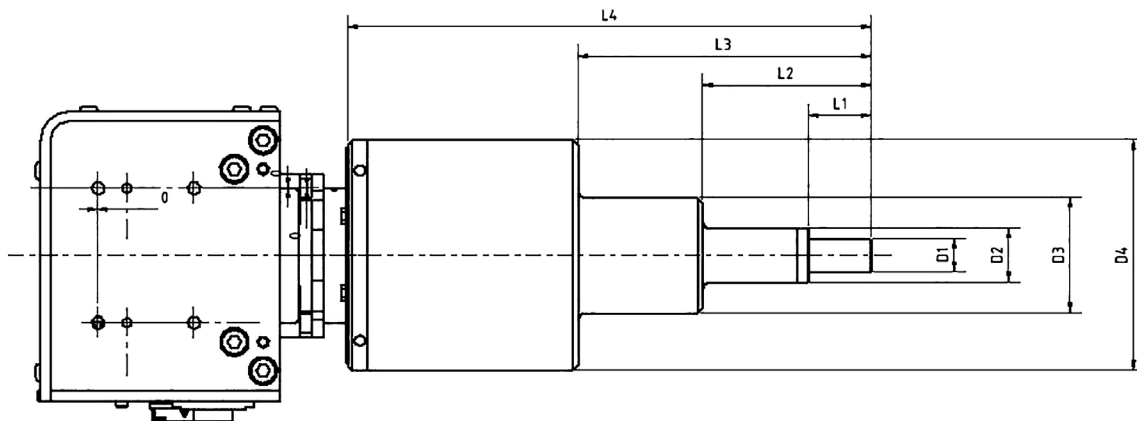

Sensor type	D20-F fixed	D20-V adjustable	D62-F fixed	D62-V adjustable	D170-F fixed	D170-V adjustable
Diameter range	20-21	20-62	62-78	62-170	170-220	170-250
L1	23,8					
L2	88		245		525	
L3	153					
L4	273		365			
D1	17					
D2	28		54		160	
D3	60					
D4	120		120			
Further interfering contour	-	D=260	-	D=260	-	

All dimensions in mm.

Bore sensor (linear)

Inspection of lateral surfaces of deep drilled holes

How it works

In contrast to the rotary sensor, the linear bore sensor captures the image by moving the sensor in the direction of the bore axis (feed direction).

This means that the bore depth to be inspected is variable and only limited by the length of the sensor shaft. An individual design and, in particular, project-specific sensor lengths are possible.

This sensor has no rotating components, making it easier to maintain than rotating sensors.

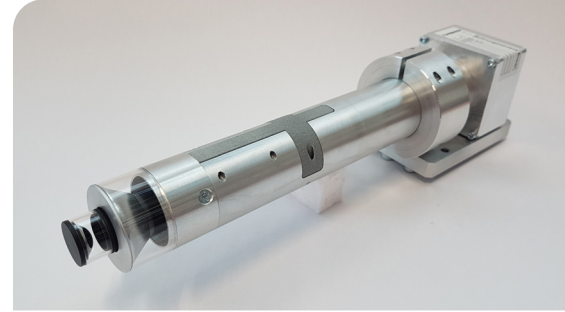

Areas of application

- » Inspection of very deep holes, e.g. crankcase bearing tunnel
- » Engine blocks
- » Electric motor housings

Sensor specifications

Sensor type	Linear bore sensor
Scan diameter	49 – 56 mm
Max. scanning depth	217 mm
Resolution	130 $\mu\text{m}/\text{px}$
Smallest detectable defect	600 x 600 μm

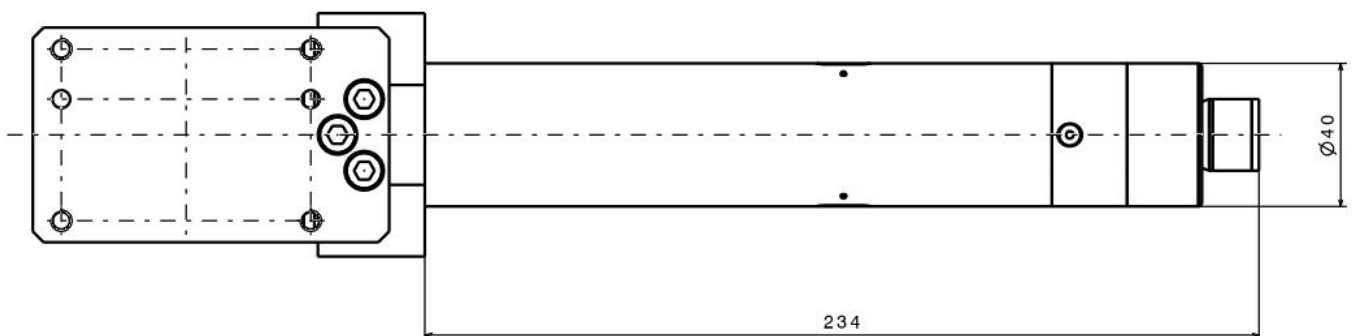

Endoscope sensors

Sensors specifically designed for narrow holes or hard-to-reach areas

How it works

Endoscope sensors are designed for narrow or deep drilled holes or surfaces that cannot be reached by other sensors due to their size. Standard endoscopes are combined with special illumination units to ensure better lighting of the areas to be inspected. This results in better defect detection.

These endoscope sensors can detect defects up to a minimum of 600 x 600 µm.

Rigid endoscope sensor from 4 mm diameter

- » For very small bore diameters from 4 mm diameter.
- » Lighting is coupled internally.

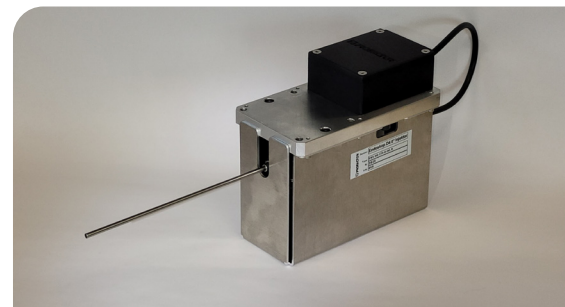

Endoscope sensor with rotating counter aperture from 11 mm diameter

- » For medium bore diameters from 11 mm diameter.
- » The sensor has lighting on the sensor tip; this rotates to ensure a 360° image.

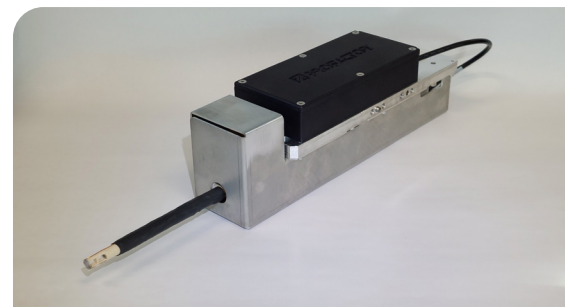

Endoscope sensor with ring light from 25 mm diameter

- » For inspecting blind holes up to a depth of 20 mm and a diameter from 25 mm.
- » For concealed locations in the component.



Areas of application

- » Inspection of machined components (e.g. engine blocks, electric motor housings, cylinder heads, etc.)
- » deep bores, blind holes
- » difficult to access mounting points

Quality data visualization & analysis

We generate added value from your inspection data

Industrial augmented reality for final inspection

Despite the use of automatic inspection systems, the final pass/fail decision for components identified as faulty often lies with quality experts at the final inspection station.

This task is often very strenuous and can only be mastered with a great deal of experience.

Profactor solution

Our industrial augmented reality visualization offers significant relief for your employees at the final inspection station.

The system projects quality data from the inspection together with instructions for the employee directly onto the respective surface of the component at the final inspection station.

Critical areas are visually highlighted and the final inspection can be carried out much more easily and quickly.

- » Visualization directly on the component
- » Minimization of errors
- » Reduced burden on employees
- » Minimal training effort

Data analysis

Feedback of quality data from inspection into the process is becoming increasingly important in order to continuously improve production.

Systematic and continuous analysis of the inspection results is thus essential.

The aim is to use the inspection data to identify as yet unrecognized changes in the upstream production steps or the supply chain, based on the inspection data.

The PROFACTOR analysis framework offers the following advantages:

- » Interactive analysis and visualization of data according to parameters like component type, defect type, production time
- » Statistical evaluation of all inspection data
- » Classification of defects
- » Identification of trends through time series analysis
- » Derivation of changes in upstream process steps
- » Use of the analysis results for predictive maintenance
- » Secure storage and archiving of measurement data
- » Documentation of the analysis results

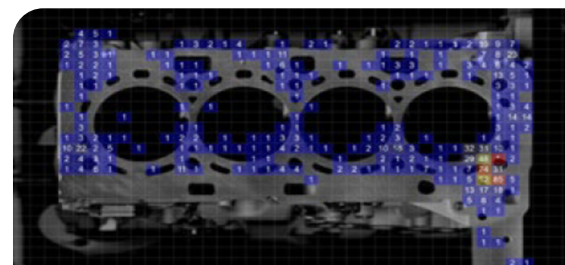
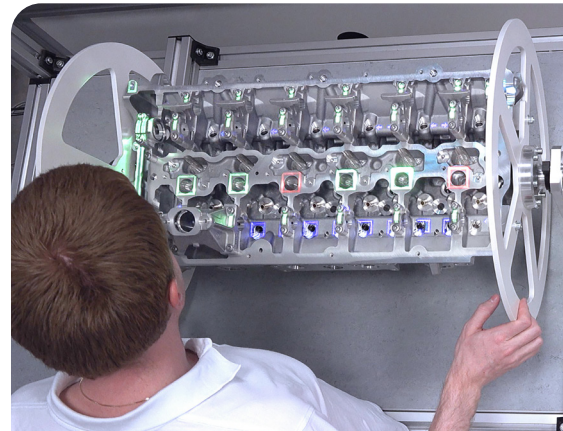

Intuitive display of defect frequencies from a series of measurements



Labeling of defect classification and defect parameters

Industrial inspection systems

Complete solutions for quality assurance in your production

PROFACTOR is your partner when it comes to demanding industrial inspection tasks.

We offer not only sensor components, but also complete turnkey solutions, from compact individual measuring stations to highly complex optical inspection systems.

Our 20 years of experience in the development of sensor technology and application in industrial production environments are the basis for complete customized solutions for your measurement tasks.

Our solutions are geared towards your measurement requirements and offer a high degree of flexibility thanks to freely configurable inspection parameters. The systems have a modular design and can therefore be easily adapted to future requirements.

Functions that have already been integrated around the sensor systems:

- » Robot solutions or stationary superstructures
- » Various automated loading/unloading systems
- » Additional functions such as OCR, barcode reader, ...
- » Presence monitoring of add-on parts
- » Industry 4.0-capable thanks to the connection to data acquisition and control systems

We can look back on many years of relationships with customers in the manufacturing industry and can also offer you our experience and expertise, from the concept feasibility to implementation of the turnkey inspection system.

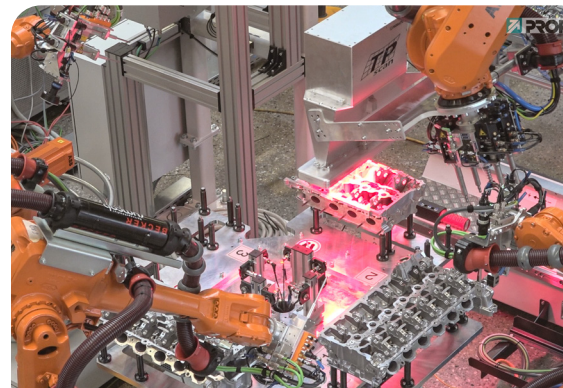

Complete solution for the inspection of engine blocks

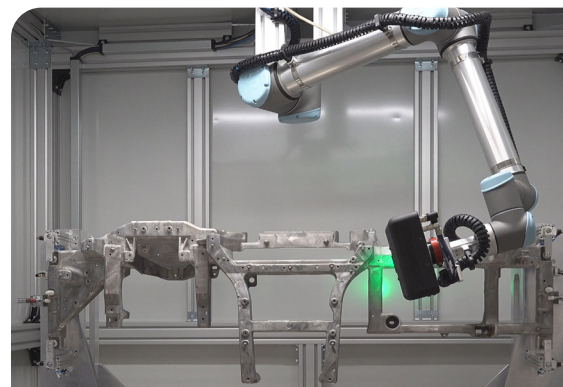

Complete solution for the inspection of aluminum structural components

References

PROFACTOR's inspection solutions have been used successfully for many years in the production lines of numerous customers, including:



+GF+

ALBERT WEBER

zmt
AUTOMOTIVE

OBB

MAGNA

NEUMAN
ALUMINIUM

FOERSTER

Häcker
kitchen.germanMade.

PROFACTOR – Your advanced technology partner

Industrial Inspection – Digital Assistance – Collaborative Robotics – Freeform Inkjet Printing – Printed Electronics – Micro and Nano Manufacturing

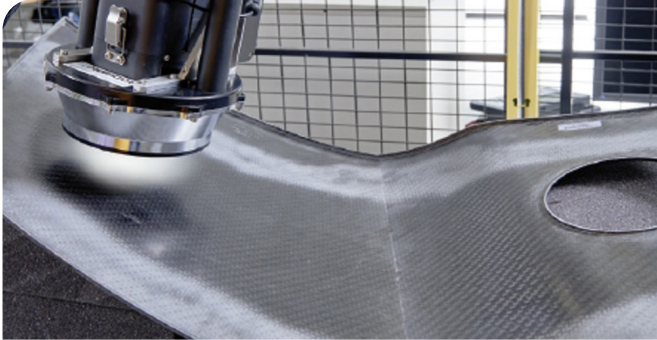

Inspection of carbon composite components and materials

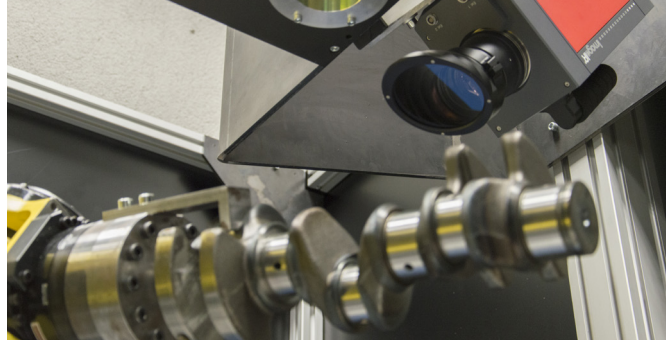

Industrial thermography: automated non-destructive crack detection



Q-Station: quality control and assistance for dynamic assembly line scenarios

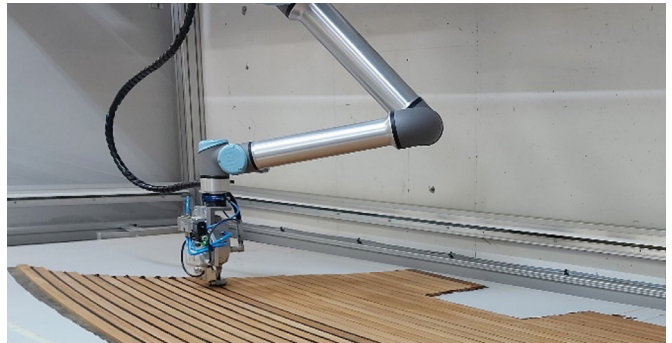

Collaborative machining, handling and (dis)assembling

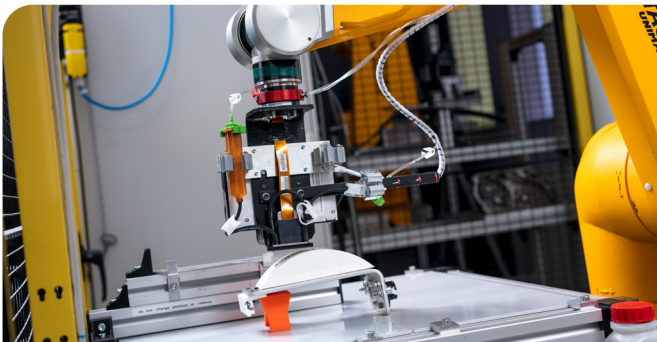

Freeform inkjet printing systems & Printed Electronics

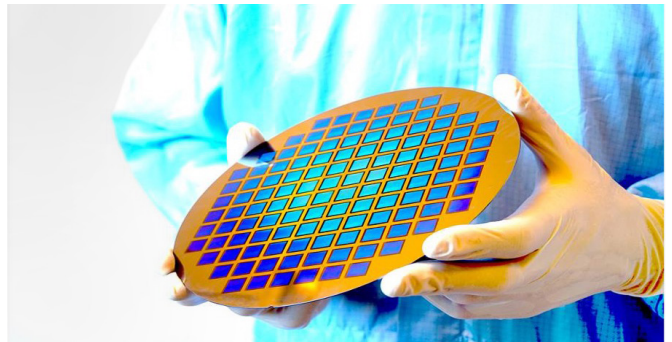

Nanoimprint Lithography (NIL) prototyping and small series manufacturing



PROFACTOR GmbH
Im Stadtgut D1
4407 Steyr-Gleink
Austria

Contact: Christoph Brandstätter
Tel. +43 (0)7252-885-252
solutions@profactor.at
www.profactor.at/inspection



Member of
UAR INNOVATION
NETWORK

#upperVISION2030
Wirtschafts- & Forschungsstrategie OÖ



Funded by the ERDF (European Regional Development Fund) as well as the federal government and the province of Upper Austria